

Entry-level IP Phone with 1 Line

The SIP-T19P E2 is one of Yealink's latest answers for the entry-level IP phone that offers features and performance normally associated with much more advanced phones. The quite intentional choice of high-quality materials, combined with a generously large 132x64-pixel graphical LCD that gives a clear 5-line display, guarantees both a smoother user experience and easier access to much more visual information at a glance. Dual 10/100 Mbps network ports with integrated PoE are ideal for extended network use. The SIP-T19P E2 supports single VoIP account, simple, flexible and secure installation options, plus IPv6 and SRTP/HTTPS/TLS, VLAN and QoS. It includes headset use, wall-mountable and has been designed very specifically for better business.



Key Features and Benefits

Enhanced Call Management

The SIP-T19P E2 supports vast productivity-enhancing features such as XML Browser, call park, call pickup, call forward, call transfer, 3-way conference, which makes it the natural and obvious efficiency tool for today's busy small and large offices environment.

Efficient Installation and Provisioning

The Yealink SIP-T19P E2 supports efficient provisioning and effortless mass deployment with Yealink's Redirection and Provisioning Service (RPS) and Boot mechanism to help you realize the Zero Touch Provisioning without any complex manual settings, which makes the SIP-T19P E2 simple to deploy, easy to maintain and upgrade.

Highly Secure Transport and Interoperability

The communicator uses SIP over Transport Layer Security (TLS/SSL) to provide service providers with the latest technology for enhanced network security. The range is certified compatible with 3CX and Broadsoft Broadworks, ensuring excellent compatibility with leading soft switch suppliers.

- > 132x64-pixel graphical LCD
- > Two-port 10/100 Ethernet Switch
- > PoE support
- > Opus codec support
- > Up to 1 SIP account
- > Headset support
- > Wall mountable
- > Simple, flexible and secure provisioning options

Audio Features

- > Codec: Opus, G.722, G.711(A/μ), G.729AB, G.726, iLBC
- > DTMF: In-band, Out-of-band (RFC 2833) and SIP INFO
- > Full-duplex hands-free speakerphone with AEC
- > VAD, CNG, AEC, PLC, AJB, AGC

Phone Features

- > 1 VoIP account
- > Call hold, mute, DND
- > One-touch speed dial, hotline
- > Call forward, call waiting, call transfer
- > Group listening, SMS
- > Redial, call return, auto answer
- > Local 3-way conferencing
- > Direct IP call without SIP proxy
- > Ring tone selection/import/delete
- > Set date time manually or automatically
- > Dial plan
- > XML Browser, action URL/URI
- > Integrated screenshots
- > RTPC-XR
- > Enhanced DSS Key

Directory

- > Local phonebook up to 1000 entries
- > Black list
- > XML remote phonebook
- > Smart dialing
- > Phonebook search/import/export
- > Call history: dialed/received/missed/forwarded

IP-PBX Features

- > Anonymous call, anonymous call rejection
- > Hot-desking, emergency call
- > Message Waiting Indicator (MWI)
- > Voice mail, call park, call pickup
- > Intercom, paging, music on hold
- > Call completion
- > Flexible seating
- > Executive and Assistant
- > Centralized call recording
- > Visual Voice Mail

Display and Indicator

- > 132x64-pixel graphical LCD
- > LED for call and message waiting indication
- > Intuitive user interface with icons and soft keys
- > Multilingual user interface
- > Caller ID with name and number
- > Power saving

Feature Keys

- > 6 features keys: message, headset, redial, transfer, mute, hands-free speakerphone
- > 5 navigation keys
- > Volume control keys

Interface

- > 2 x RJ45 10/100M Ethernet ports
- > Power over Ethernet (IEEE 802.3af), class 1
- > 1 x RJ9 (4P4C) handset port
- > 1 x RJ9 (4P4C) headset port

Other Physical Features

- > Wall mountable
- > External Yealink AC adapter (optional): AC 100~240V input and DC 5V/600mA output
- > Power consumption (PSU): 0.9-1.3W
- > Power consumption (PoE): 1.2-1.8W
- > Dimension (W*D*H*T): 185mm*188mm*143mm*38mm
- > Operating humidity: 10~95%
- > Operating temperature: -10~50°C (+14~122°F)

Management

- > Configuration: browser/phone/auto-provision
- > Auto provision via FTP/TFTP/HTTP/HTTPS for mass deploy
- > Auto-provision with PnP
- > Zero-sp-touch, TR-069
- > Phone lock for personal privacy protection
- > Reset to factory, reboot
- > Package tracing export, system log

Network and Security

- > SIP v1 (RFC2543), v2 (RFC3261)
- > Call server redundancy supported
- > NAT traversal: STUN mode
- > Proxy mode and peer-to-peer SIP link mode
- > IP assignment: static/DHCP
- > HTTP/HTTPS web server
- > Time and date synchronization using SNTP
- > UDP/TCP/DNS-SRV (RFC 3263)
- > QoS: 802.1p/Q tagging (VLAN), Layer 3 ToS DSCP
- > SRTP for voice
- > Transport Layer Security (TLS)
- > HTTPS certificate manager
- > AES encryption for configuration file
- > Digest authentication using MD5/MD5-session
- > IEEE802.1X
- > IPv6
- > LLDP/CDP/DHCP VLAN
- > ICE

Package Features

- > Package content:
 - Yealink SIP-T19P E2 IP phone
 - Handset with handset cord
 - Ethernet Cable (1.5m CAT5E UTP Cable)
 - Stand
 - Quick Start Guide
 - Power Adapter (Optional)
- > Qty/CTN: 10 PCS
- > N.W/CTN: 9.8 kg
- > G.W/CTN: 10.8 kg
- > Giftbox size: 215mm*200mm*121mm
- > Carton Meas: 630mm*436mm*210mm

Compliance

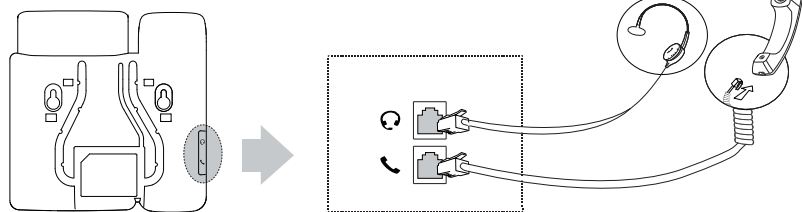
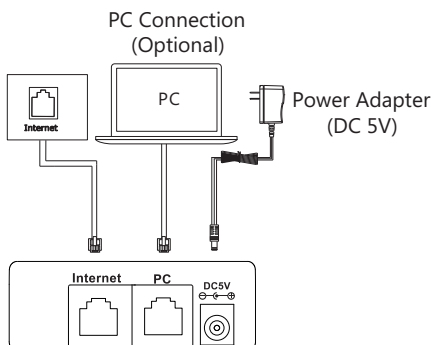

Learn More

To find out how Yealink solutions can help your organization, visit us at www.yealink.com or mail to sales@yealink.com



About Yealink

Yealink (Stock Code: 300628) is a global leading unified communication (UC) terminal solution provider that primarily offers video conferencing systems and voice communication solutions. Founded in 2001, Yealink leverages its independent research and development and innovation to pursue its core mission: "Easy collaboration, high productivity." The company's high-quality UC terminal solutions enhance the work efficiency and competitive advantages of its customers in over 100 countries. Yealink is the world's second-largest SIP phone provider and is number one in the China market.

Copyright

Copyright © 2017 YEALINK(XIAMEN) NETWORK TECHNOLOGY CO., LTD.

Copyright © 2017 Yealink(Xiamen) Network Technology CO., LTD. All rights reserved. No parts of this publication may be reproduced or transmitted in any form or by any means, electronic or mechanical, photocopying, recording, or otherwise, for any purpose, without the express written permission of Yealink(Xiamen) Network Technology CO., LTD.

Technical Support

Visit Yealink WIKI (<http://support.yealink.com/>) for firmware downloads, product documents, FAQ, and more. For better service, we sincerely recommend you to use Yealink Ticketing system (<https://ticket.yealink.com>) to submit all your technical issues.



YEALINK(XIAMEN) NETWORK TECHNOLOGY CO.,LTD.
Web: www.yealink.com
Addr: 309, 3th Floor, No.16, Yun Ding North Road,
Huli District, Xiamen City, Fujian, P.R. China
Copyright©2017Yealink Inc.All right reserved.